

IV68 serramento legno

sezione verticale

base
versione legno

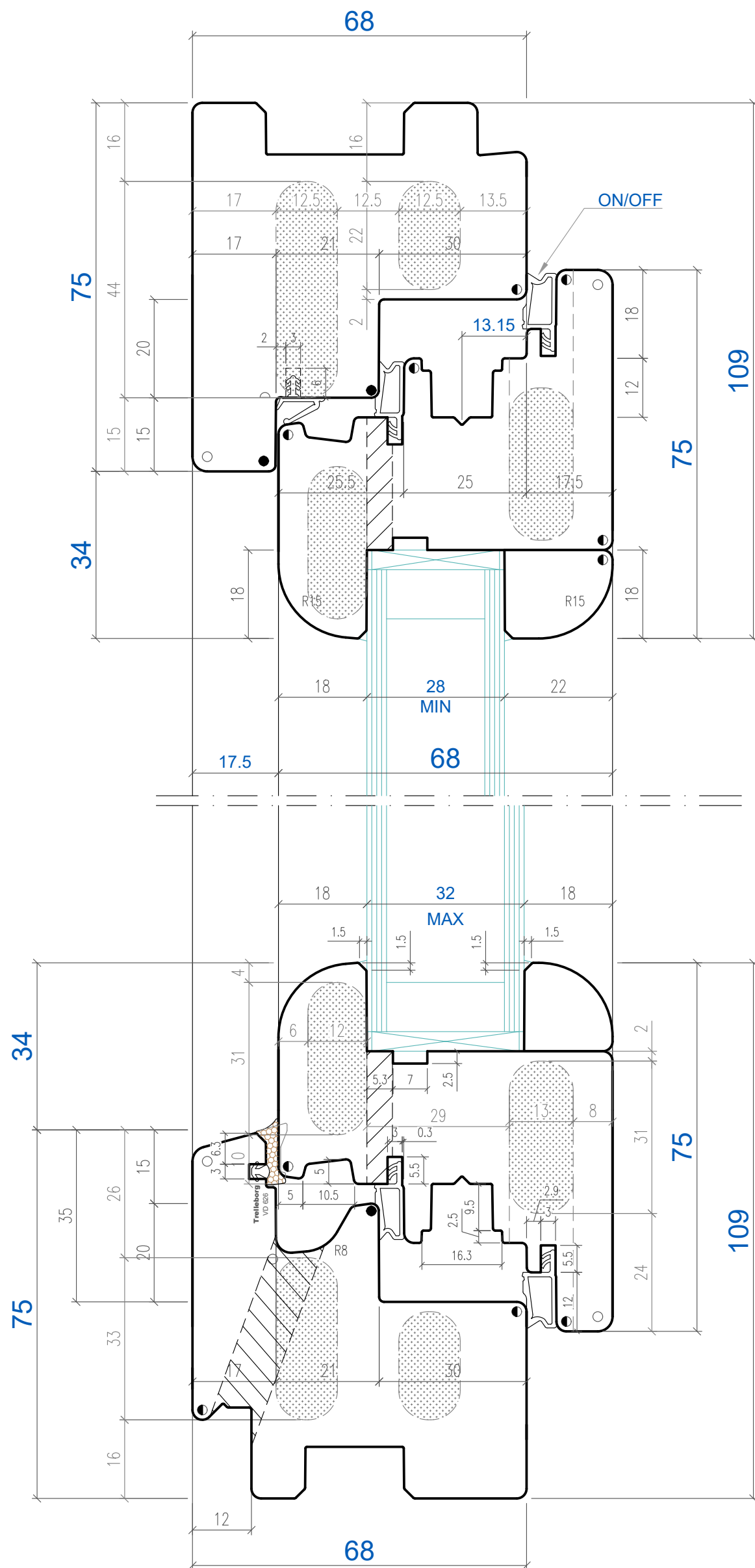

- ⊖ R 1.0
- R 1.5
- R 2.0
- R 3.0

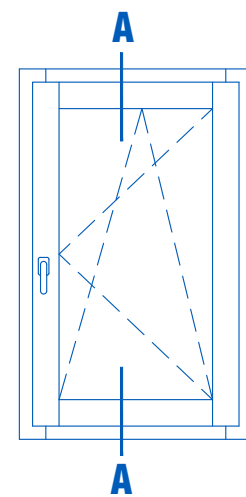

IV68 serramento legno

sezione orizzontale

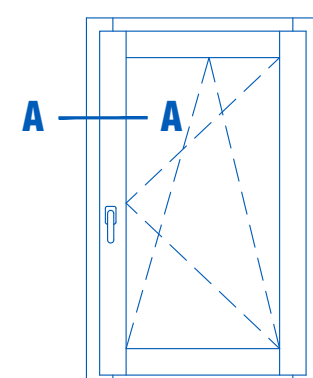
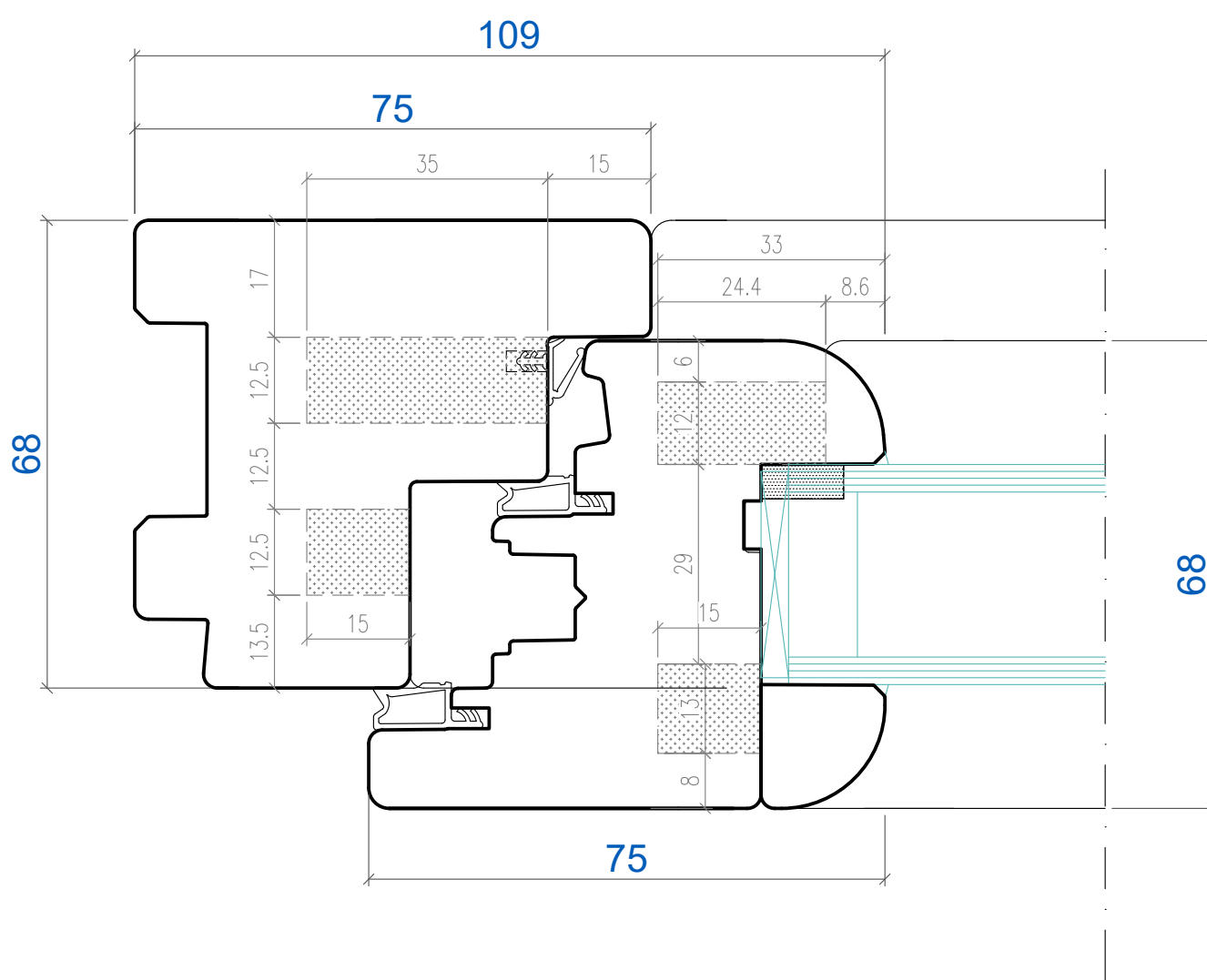

- ⊖ R 1.0
- R 1.5
- R 2.0
- R 3.0

IV68 serramento legno

sezione orizzontale



battuta centrale asimmetrico

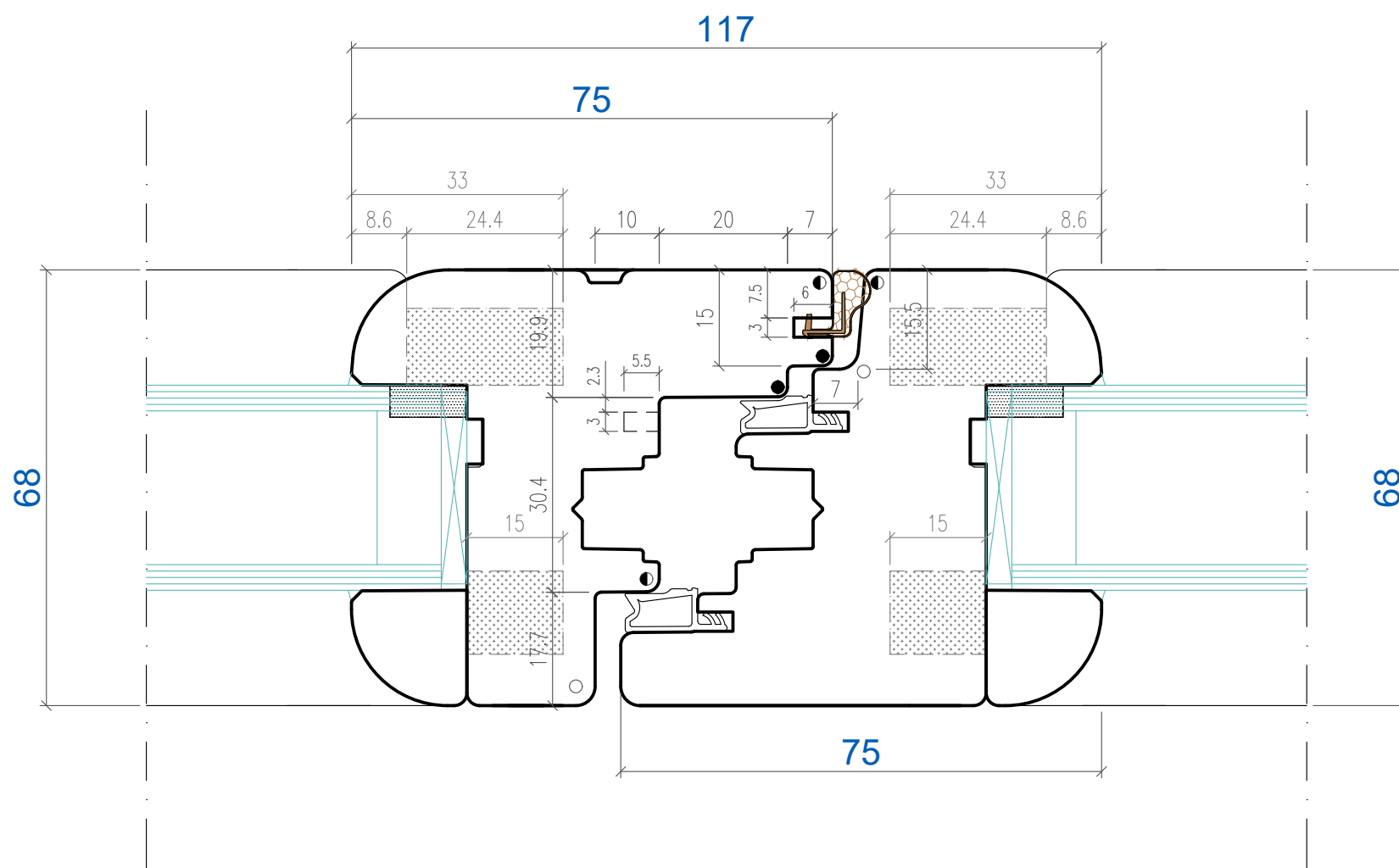

- ⊖ R 1.0
- R 1.5
- R 2.0
- R 3.0

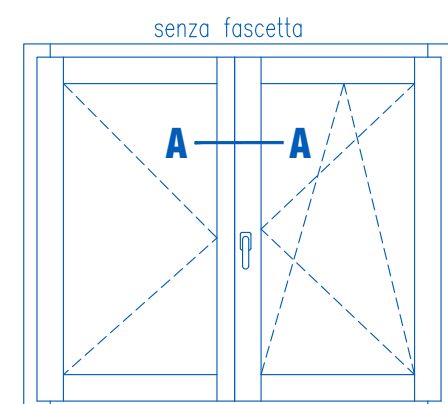

IV68 serramento legno

sezione orizzontale



battuta centrale con fascetta

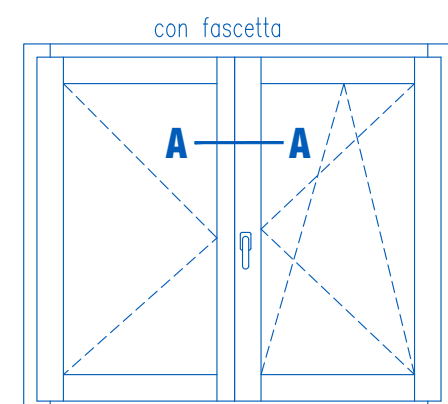
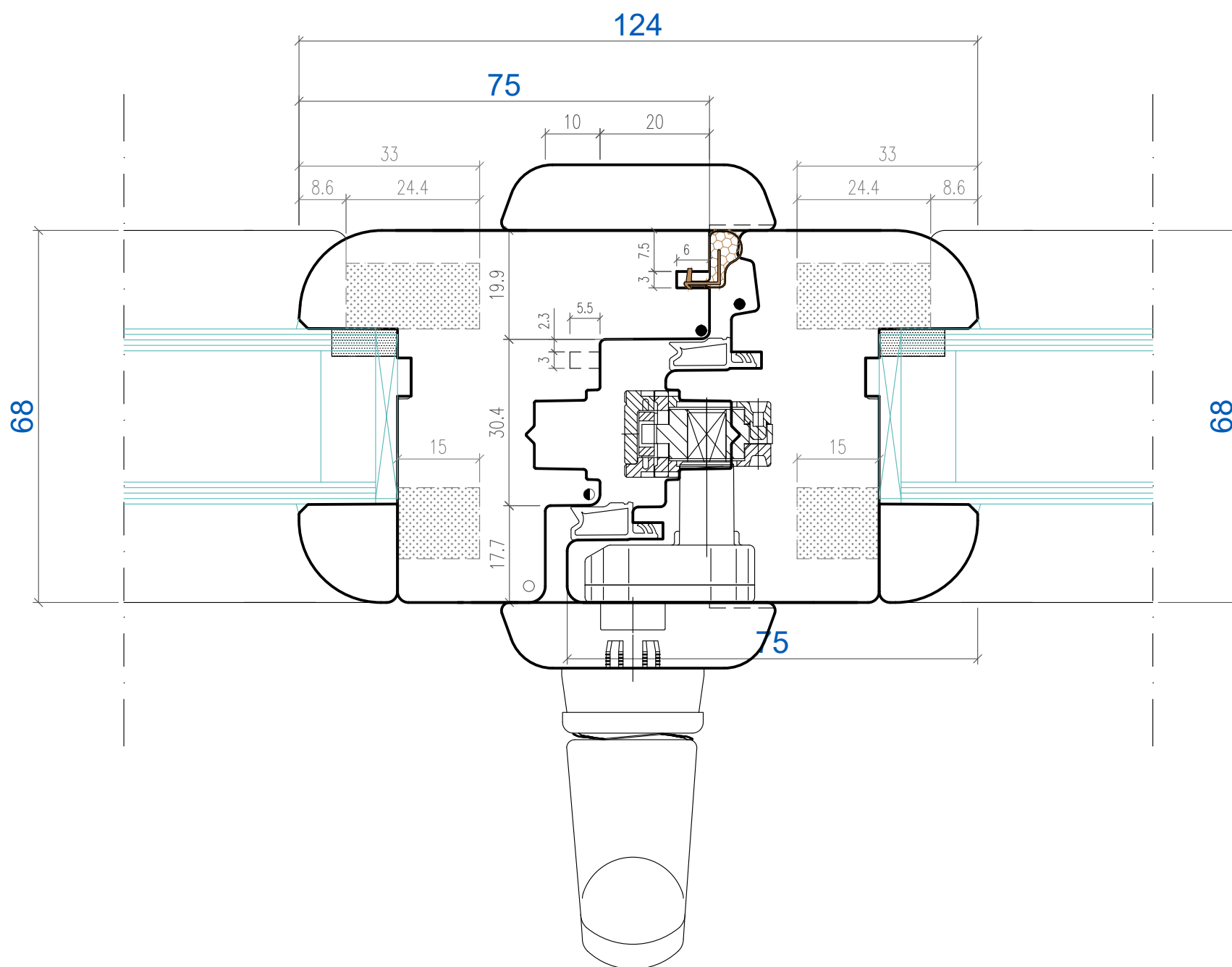

- ⊖ R 1.0
- R 1.5
- R 2.0
- R 3.0

IV68 serramento legno

sezione verticale



porta finestra con traverso aggiunto
con soglia - due guarnizioni

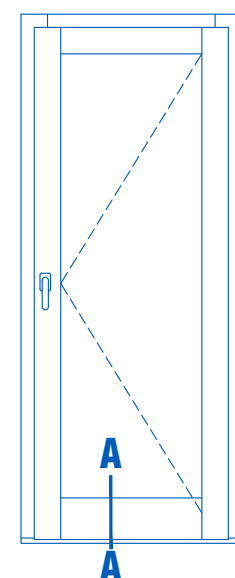
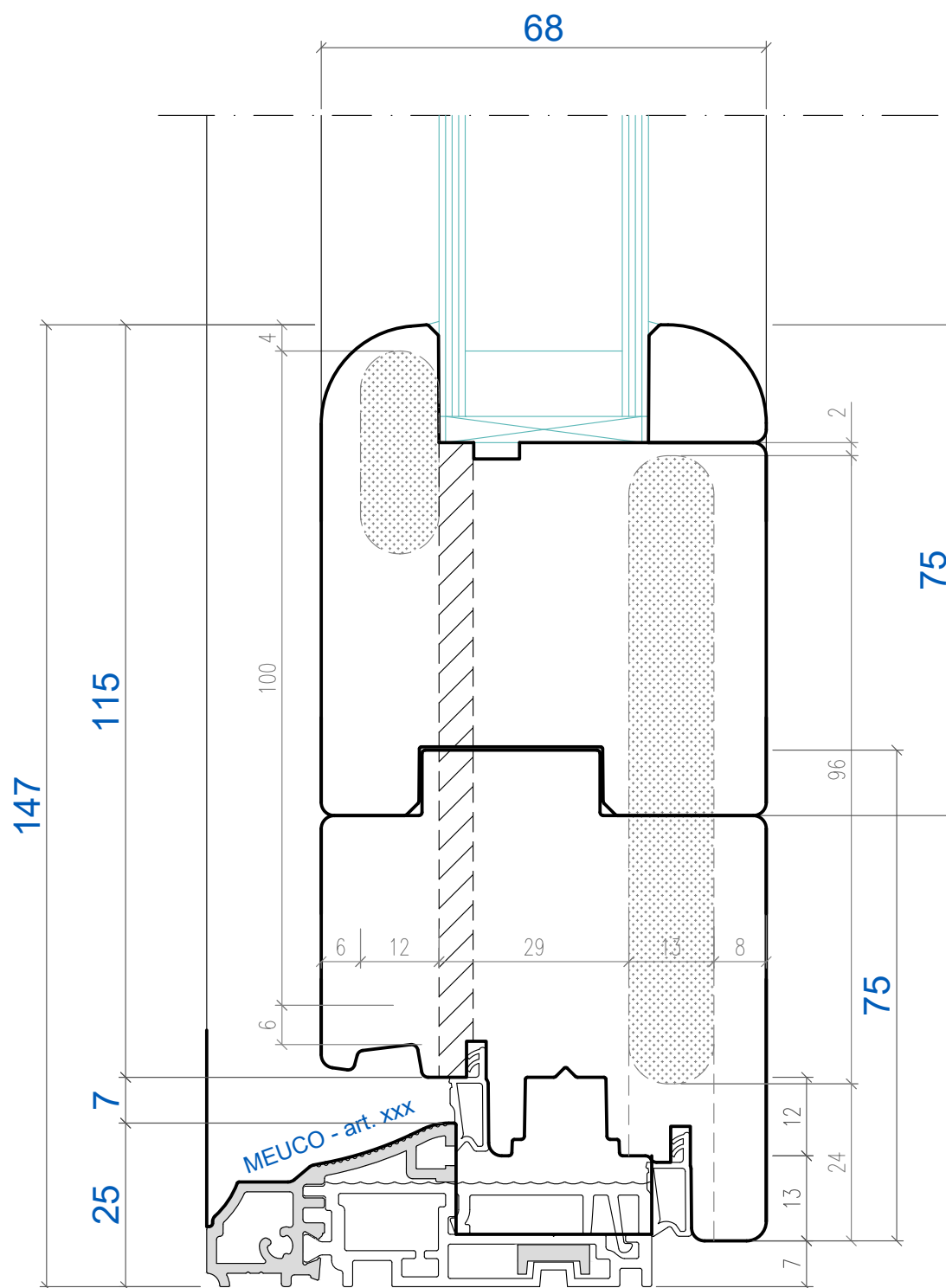

- R 1.0
- R 1.5
- R 2.0
- R 3.0

dis. e. contr. 07.12.2021 ESC
Prestare attenzione alla normativa ISO 16016

L 197002132

PZ05

IV68 serramento legno

telaio esterno STANDARD
accoppiamento femina con battuta coprifilo

profili telaio esterno

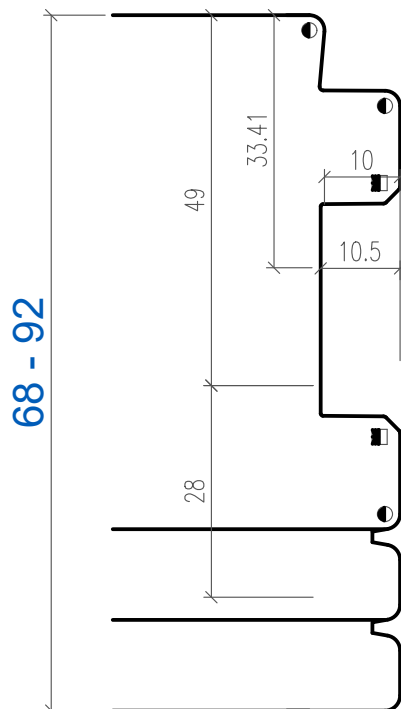

accoppiamento femina

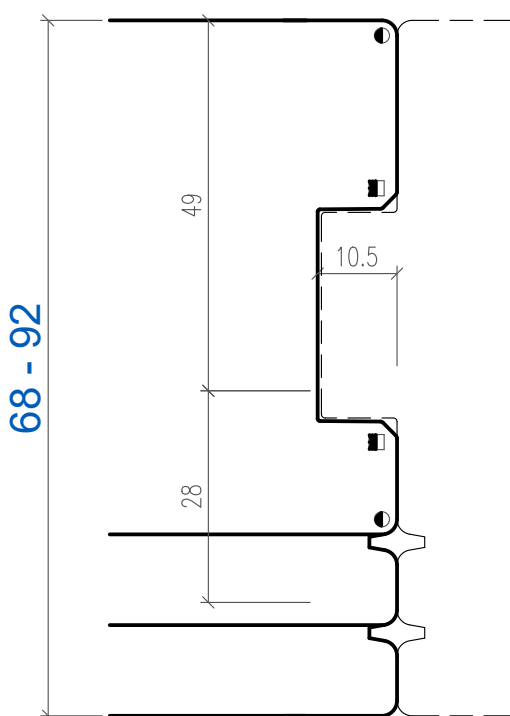

accoppiamento maschio

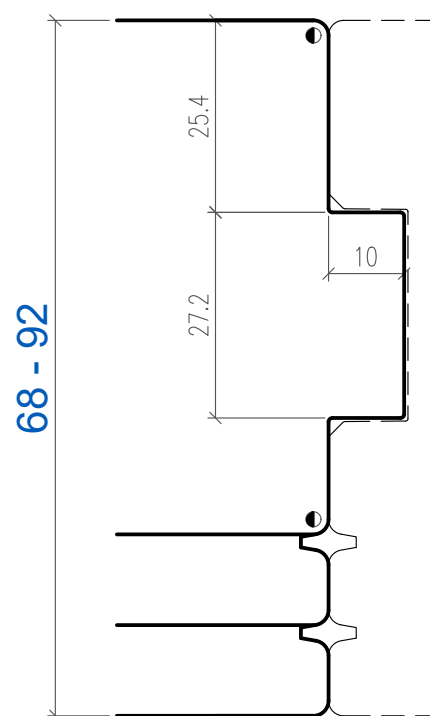

telaio esterno inclinato

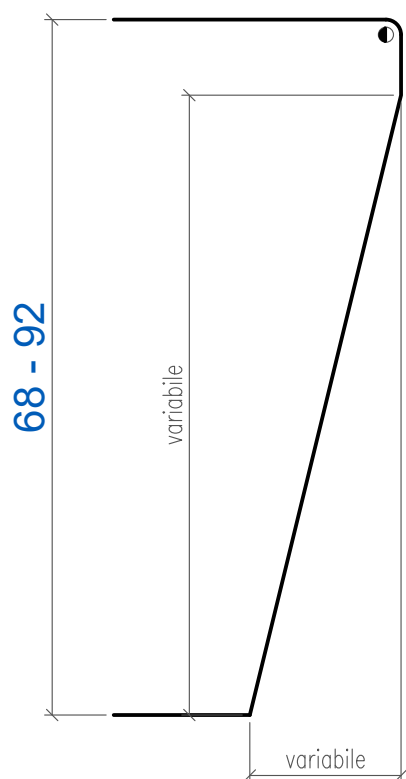

battute variabili
interno e esterno

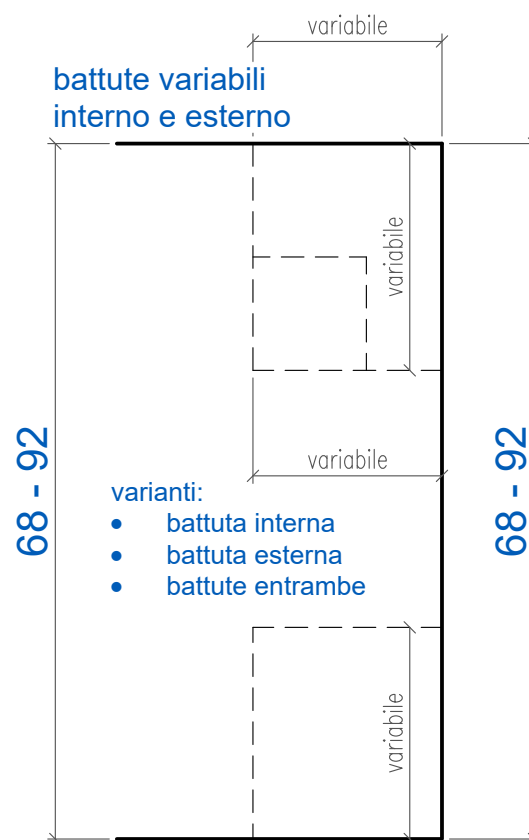

varianti:

- battuta interna
- battuta esterna
- battute entrambe

- R 1.0
- R 1.5
- R 2.0
- R 3.0

IV68 serramento legno

sezione verticale



vetro fisso laterale
superiore e inferiore con scambio battuta

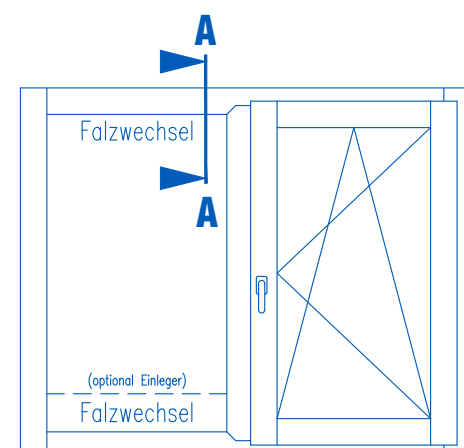
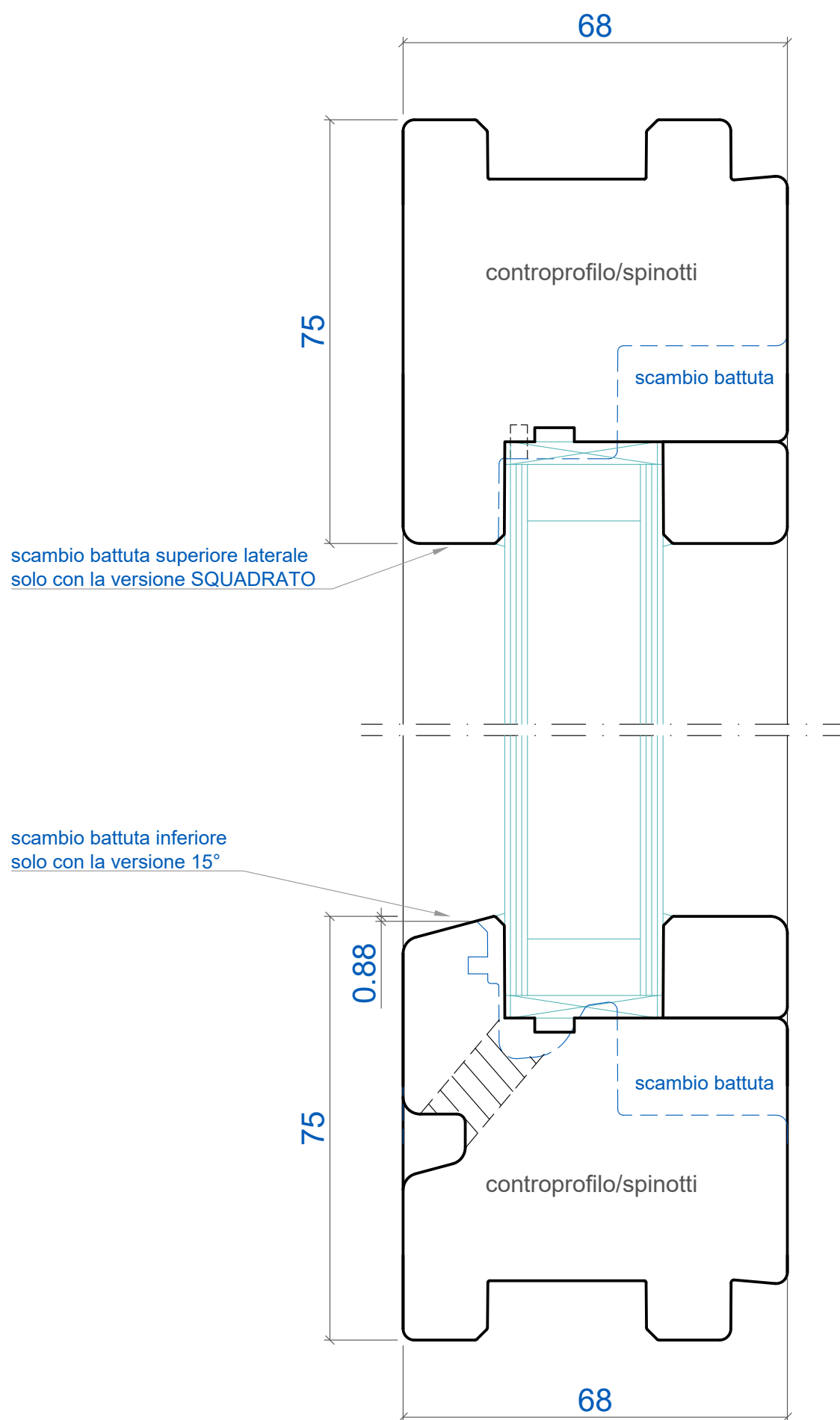

- ⊖ R 1.0
- R 1.5
- R 2.0
- R 3.0

IV68 serramento legno

sezione verticale



vetro fisso laterale
fianco luce

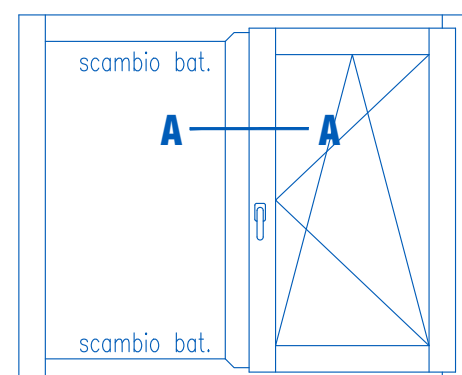
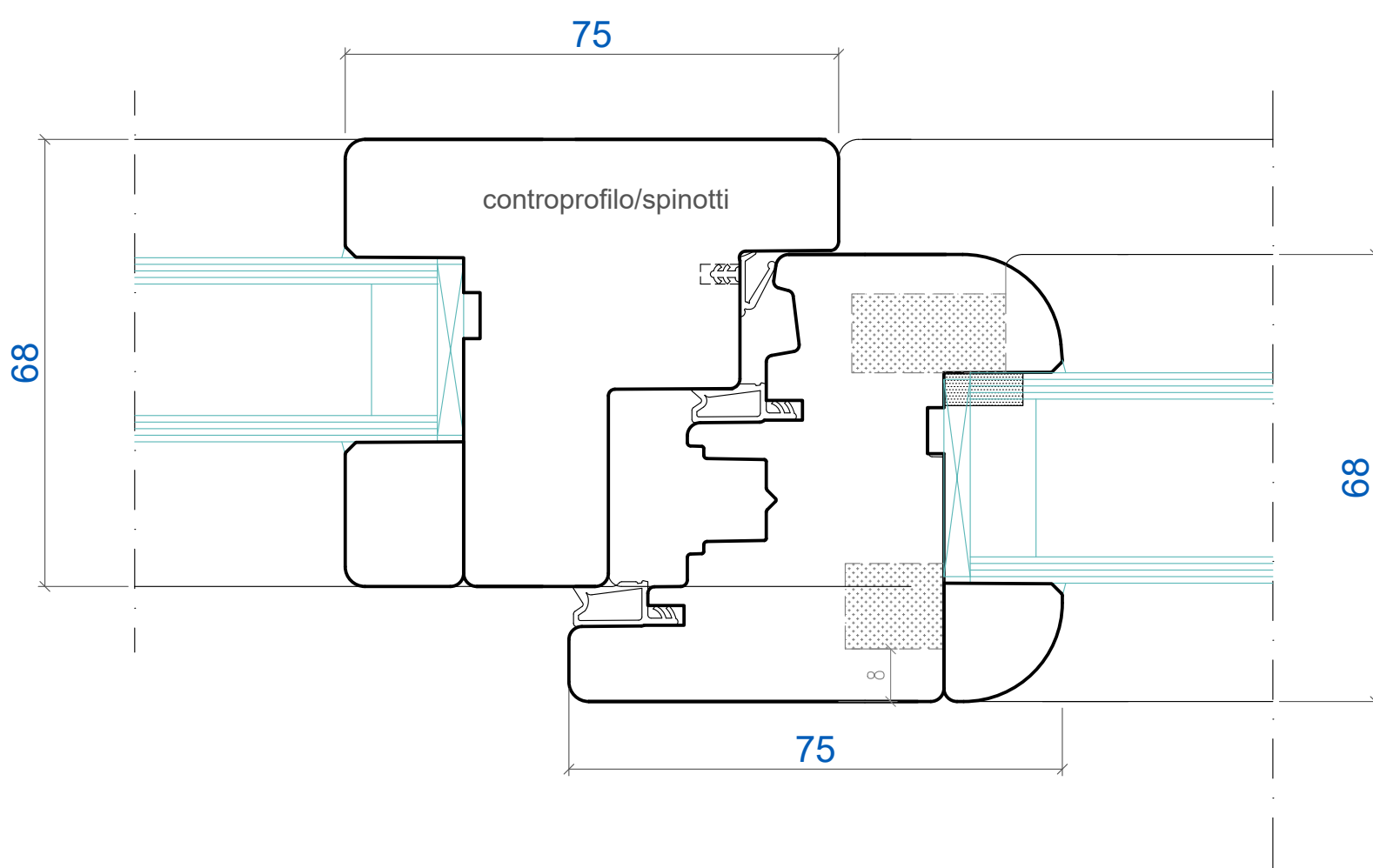

- ⊖ R 1.0
- R 1.5
- R 2.0
- R 3.0

IV68 serramento legno

sezione verticale



vetro fisso superiore/inferiore
sopra/sotto luce

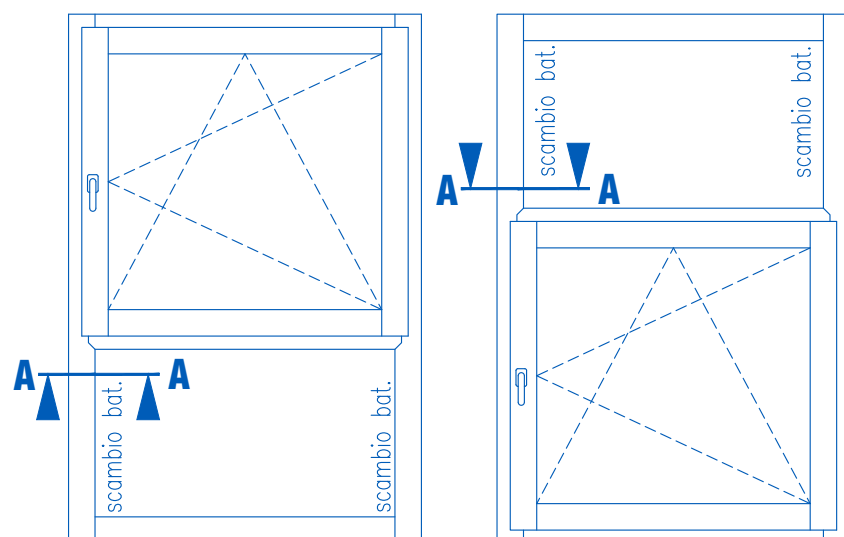
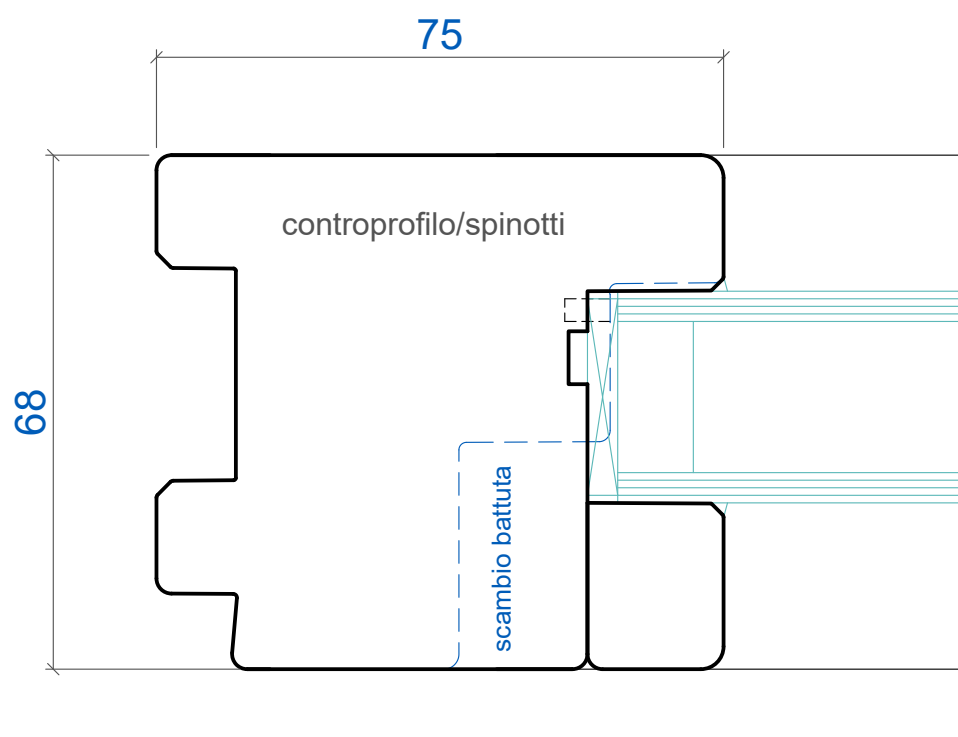

- R 1.0
- R 1.5
- R 2.0
- R 3.0

IV68 serramento legno

sezione verticale

porta finestra con fianco luce

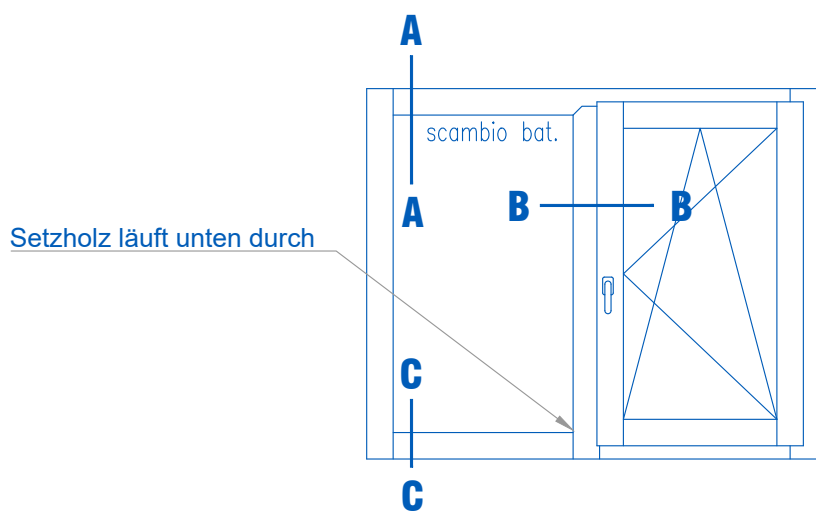
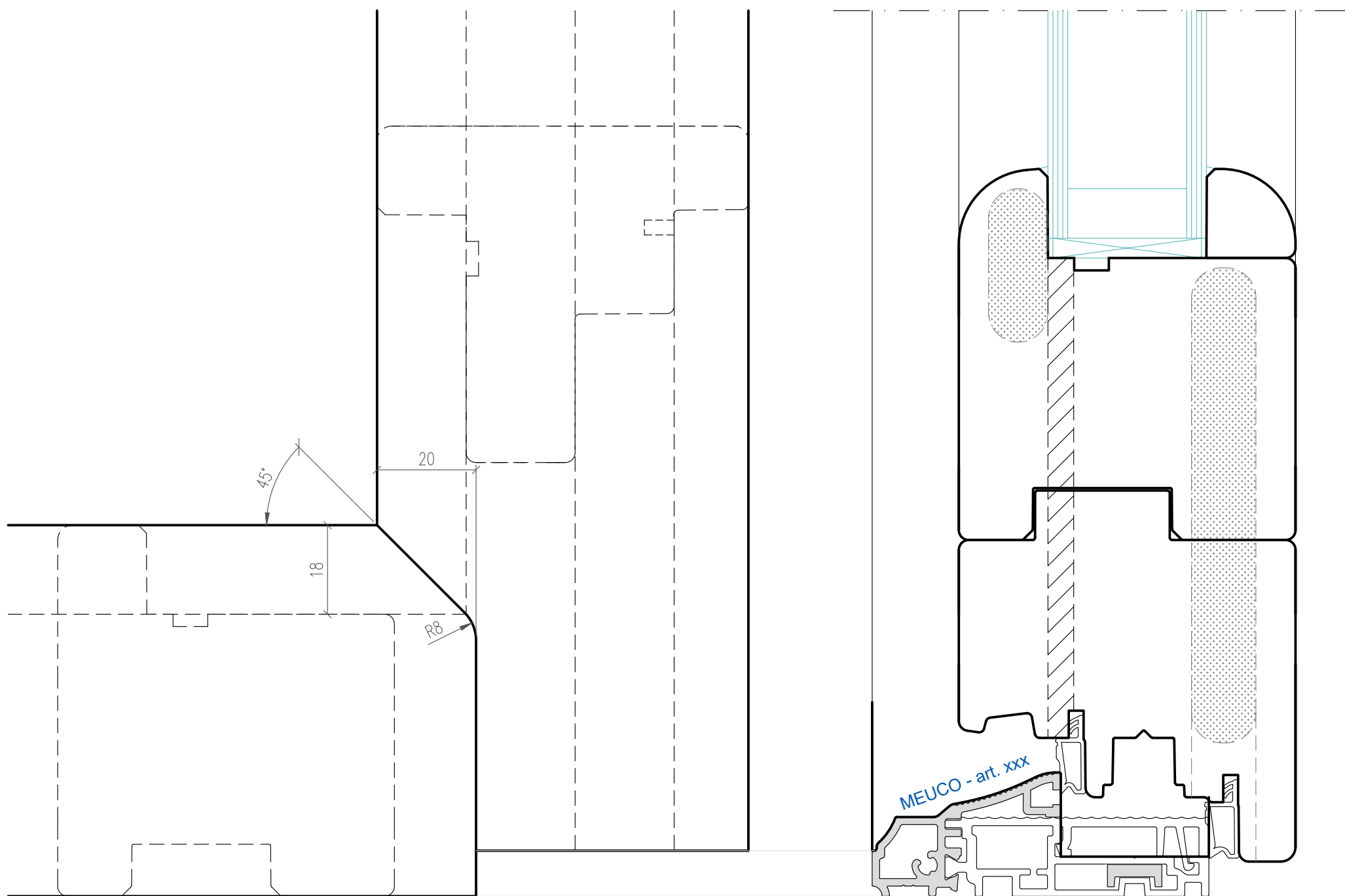

- R 1.0
- R 1.5
- R 2.0
- R 3.0

IV68 serramento legno

sezione verticale



versione SQUADRATO

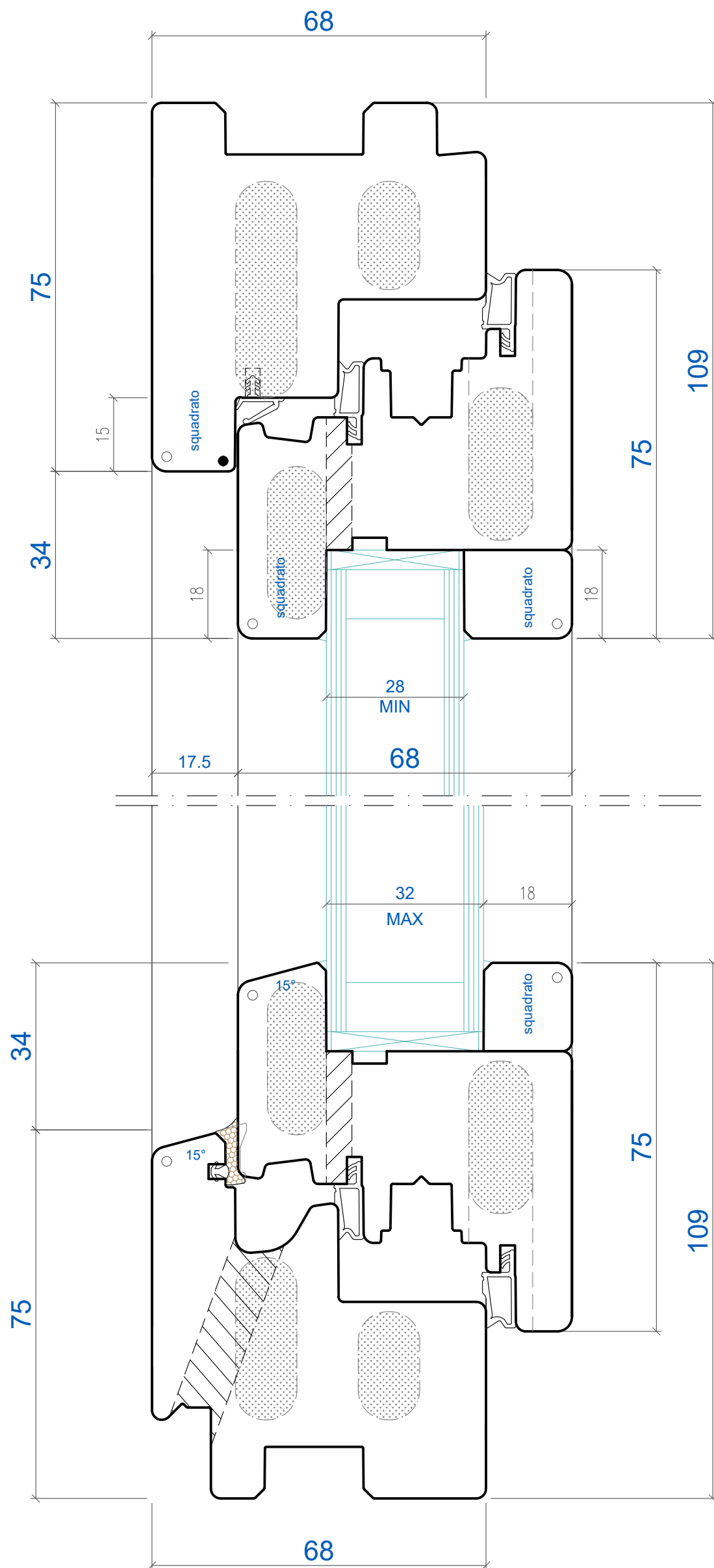

- ⊖ R 1.0
- R 1.5
- R 2.0
- R 3.0

dis. e. contr. 22.02.2022 ESC
Prestare attenzione alla normativa ISO 16016

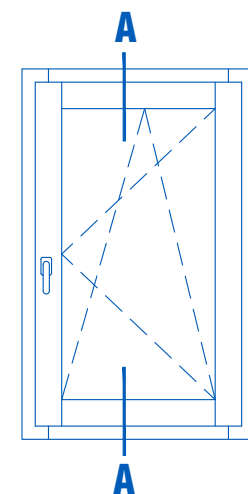

L 197002132

PZ13

IV68 serramento legno

sezione verticale

versione RUSTICA

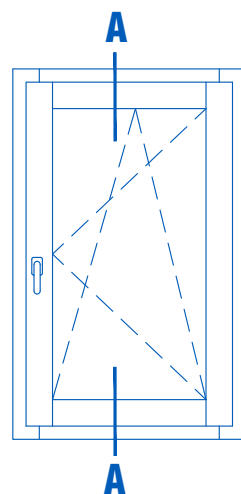
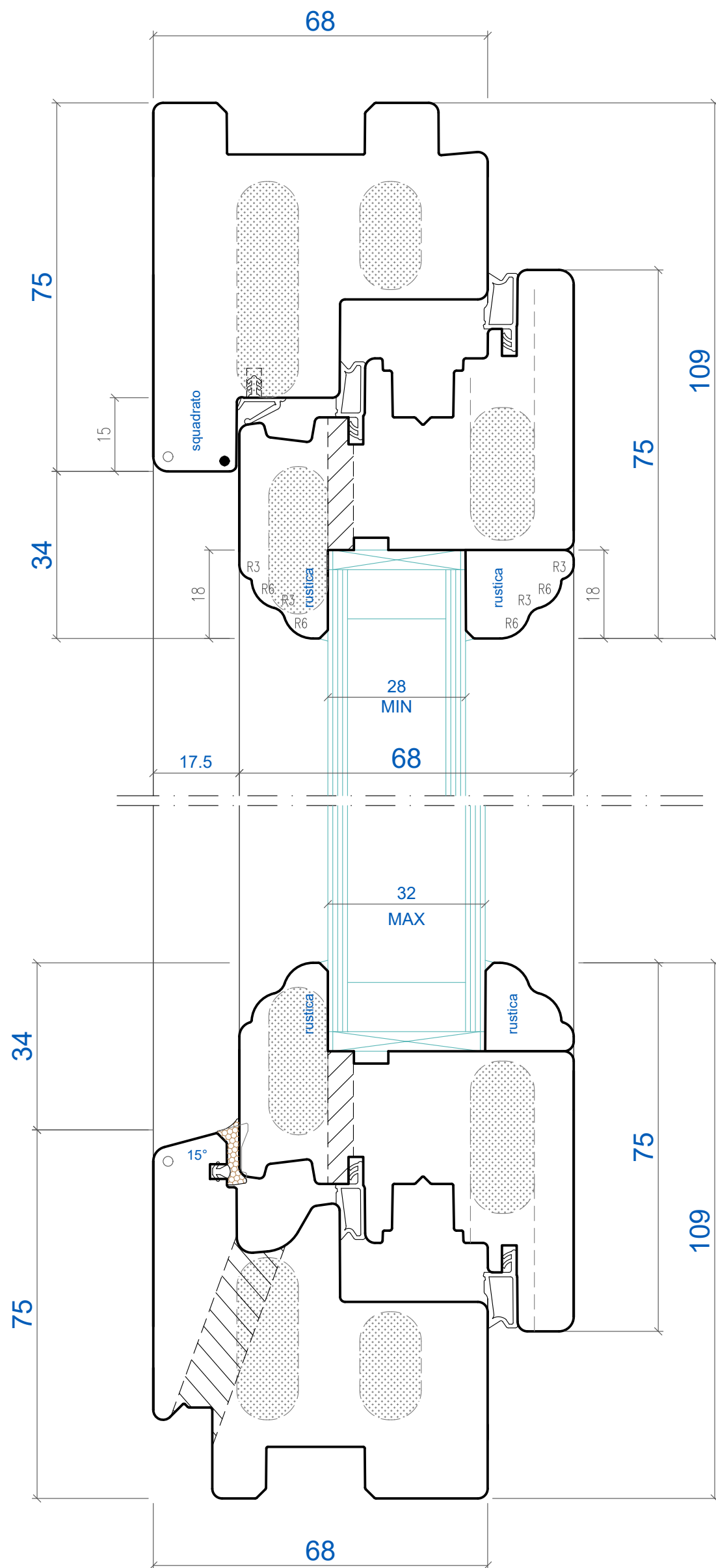

- R 1.0
- R 1.5
- R 2.0
- R 3.0